

# SUBMITTAL DATA SHEET

NI\_AP\_IN\_0033.docx  
Rev. -0 of 09/06/2022

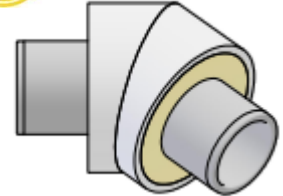



## NIRON CLIMA ALLPRO FITTINGS 45° PREINSULATED EXTENDED BEND



**ITEM:** 27NC45AP\_73MML  
**SIZE RANGE:** 1" (32 mm) ÷ 12" (315 mm)  
**SDR:** 7.3  
**FUSION RANGE:** For Butt Fusion – SDR 7.3 and up  
For Electrofusion – SDR 7.3 and up

**MATERIAL:** PP-RCT + Fiber glass + PUF + PPR jacket

**COLOR:** Grey (carrier pipe) + Grey with white outer layer (jacket pipe)

**WELDING SYSTEM:**   

### INSTALLATION INSTRUCTIONS:

In accordance with DVS 2207, ASTM D2657 and NUPI AllPro Niron Catalog/Price Sheet

### LISTINGS:

uNSF-14; ICC-ES; IAPMO

### STANDARDS:

ANS/NSF 14; ASTM F2389; CSA B137.11; CAN/ULC S 102.2

### MAXIMUM OPERATING PRESSURE:

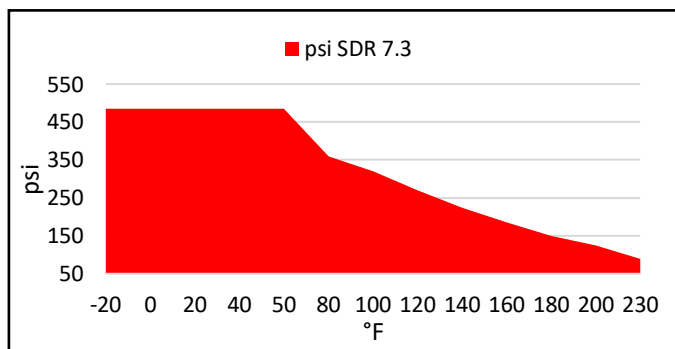

### MINIMUM INSULATION THICKNESS PER ASHRAE STANDARD 90.1:

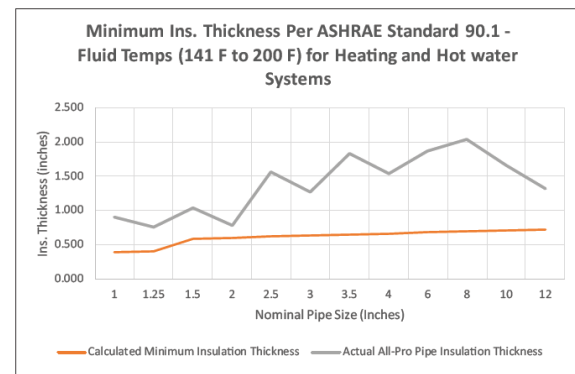

### LINEAR EXPANTION RATE:

0.23 in /10°F/100 ft

For code or standard question pertaining to NIRON CLIMA AllPro Pipe and Fittings, contact Nupi Americas.

### PRODUCT INFORMATION AND APPLICATION USE:

Niron AllPro preinsulated fittings are manufactured with Niron Clima PP-RCT carrier components that are housed within an IPS Sch. 40 jacket that is extruded with a 30 year U.V. resistant white PP-RCT external layer. The fittings are super insulated with highly efficient closed cell polyurethane foam (PUF) insulation which exceeds the required thickness for the ASHRAE 90.1 Energy Code in all sizes. This style of fitting has carrier pipes extended to allow joining by the AllPro EF or BF method. Each fitting is available in an optional "extended version" which has the centerline-to-end dimension of the fittings extended to allow for clamping in butt fusion machines which have a wide clamp set-up.



Nupi Americas, Inc.  
314 Commerce Parkway  
Early Branch, SC 29916  
Phone: 813-398-3579  
Fax: 813-398-3639  
Mail: [info@nupiamericas.com](mailto:info@nupiamericas.com)  
Website: [www.nupiamericas.com](http://www.nupiamericas.com)

# SUBMITTAL DATA SHEET

NI\_AP\_IN\_0033.docx  
Rev. -0 of 09/06/2022

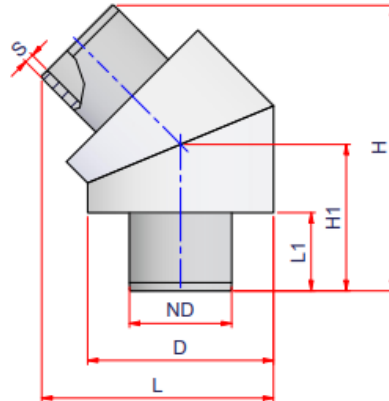

CODE	Weight lbs/pc	Volume ft <sup>3</sup> /pc	ND	D	S	L1	L	H1	H
27NC45AP3273MML	2.688	0.7821	1" => 32 mm	3.5	0.17	2	10.15	11.25	19.65
27NC45AP4073MML	2.813	0.7909	1 1/4" => 40 mm	3.5	0.22	2	10.26	11.25	19.76
27NC45AP5073MML	4.897	1.2639	1 1/2" => 50 mm	4.5	0.27	2.5	11.78	12.5	22.03
27NC45AP6373MML	4.067	1.2788	2" => 63 mm	4.5	0.34	2.5	11.97	12.5	22.16
27NC45AP7573MML	13.712	3.0836	2 1/2" => 75 mm	6.625	0.4	3	15.67	16	28.36
27NC45AP9073MML	14.574	3.1294	3" => 90 mm	6.625	0.49	3	15.88	16	28.57
27NC45AP11073MML	23.893	5.1945	3 1/2" => 110 mm	8.625	0.59	4	18.57	18	32.26
27NC45AP12573MML	25.377	5.2624	4" => 125 mm	8.625	0.67	4	18.78	18	32.47
27NC45AP16073MML	41.101	8.2291	6" => 160 mm	10.75	0.86	4.5	21.75	20	36.37
27NC45AP20073MML	57.131	12.0071	8" => 200 mm	12.75	1.08	5	24.72	22	40.34
27NC45AP25073MML	60.241	13.6458	10" => 250 mm	14.00	1.35	5.5	26.04	22	41.04
27NC45AP31573MML	67.512	19.0512	12" => 315 mm	16.00	1.70	5	29.36	24	45.36

## MANUFACTURER'S WARRANTY:

Thirty (30) Years from the date of sale upon successful completion of pressure test of the piping system (refer to published warranty for complete details).

## NOTE:

\* More information can be found on AllPro NIRON TECHNICAL CATALOGUE

\*\*\* In order for Niron pipe and fittings to meet E-84 and/or CAN/ULC S102.2 for installation in a plenum application, it must be covered with a minimum of 1" or greater E-84 fiberglass insulation

\*\*\*\* Technical Data may undergo dimensional changes, check revision at the top



Nupi Americas, Inc.  
314 Commerce Parkway  
Early Branch, SC 29916  
Phone: 813-398-3579  
Fax: 813-398-3639  
Mail: [info@nupiamericas.com](mailto:info@nupiamericas.com)  
Website: [www.nupiamericas.com](http://www.nupiamericas.com)